

ecodan
D generation



Indoor Units

All-in-one Compact Indoor Unit

- All-in one: Key functional components are incorporated
- Compact cylinder unit: Just 595x680mm footprint and 1,600mm of 200L unit height
- Compact hydro box: Only 530x360mm footprint
- Easy Installation: Factory fitted pressure relief valve
- Easy service: Relevant parts are located at the front of the unit for easy maintenance
- Easy transport: Handles attached on front and back (cylinder unit)

New Expanded Line-up

With addition of new 170L and 300L cylinders, all within the existing slim 595x680mm footprint, ecodan is the perfect solution for any situation.



Easy Installation and Low Maintenance

Simple Piping Arrangement

All water piping is aligned at the rear side of the unit for easy connection and neat finish.



Easy Adjustment

Adjust bolt capable of 50mm expansion for easy installation on uneven surfaces.



Built-in Drain Pan for Reversible Cylinder Models

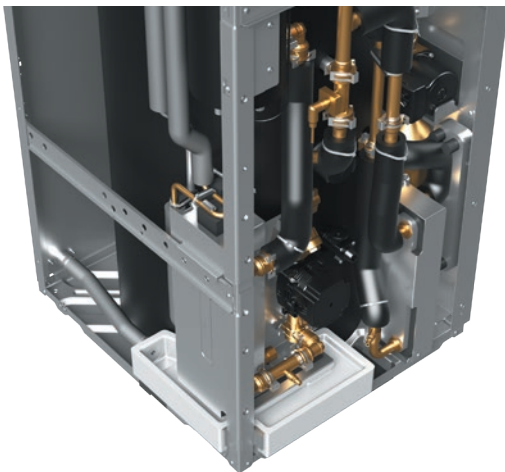

Reversible models now include a built-in space saving drain pan and the drain socket is positioned at the back of the unit. With use of the adjuster bolt, the outlet height can be higher than 50mm, allowing 5m drainage.

Initial Setting Wizard

In addition to language, date and time, you can set up hot water and heating/cooling operation, pump speed, flow rate range initial setting much simpler than previous models.

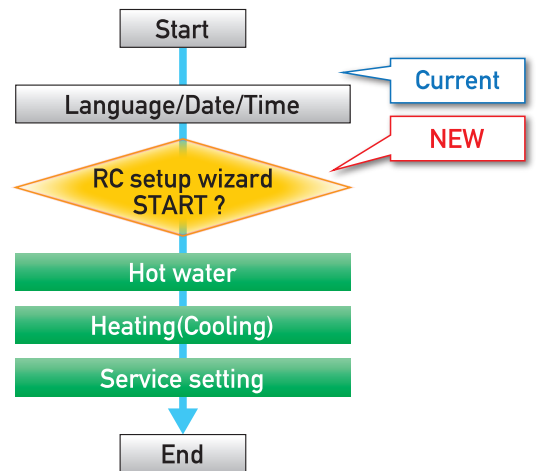

Hydro Box Piping Arrangement Improvement

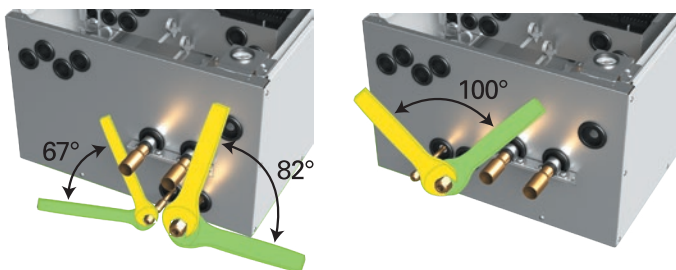

Through structural innovation related to the space around the pipes, the area where the spanner can be moved has been increased, thus improving pipe work and enabling it to be completed smoothly.

Operation Data Monitoring

Time, operation mode, flow /return/ tank temperature, can be displayed on main remote controller.

Sample display of monitoring setting

26 Feb 2019 10:00				
	THW1	THW2	THW5	Flow
10:00 ☀	41°C	38°C	54°C	20L
9:55 ☀	38°C	38°C	54°C	20L
9:50 ☀	48°C	48°C	54°C	20L
9:45 🌧	60°C	56°C	54°C	15L
9:40 🌧	59°C	55°C	52°C	15L
				(1/5)

Easy Installation and Low Maintenance

Minimum Required Water Volume

Outdoor heat pump unit		Cylinder/Hydro box containing water amount (L)	Additional required water amount (L)*1	
			Average/Warmer Climate*2	Colder Climate*2
Cylinder / Hydro box	SUZ-SWM40VA	5	1	12
	SUZ-SWM60VA		2	21
	SUZ-SWM80VA		4	29

Refer to the Indoor unit installation manual for other outdoor unit models.

*1 If there is a bypass circuit, above table means minimum water amount in case of bypass

*2 Please refer to 2009/125/EC: Energy-related Products Directive and Regulation (EU) No 813/2013 to confirm your climate zone.

Minimum Additional Water Required

In average/warmer conditions, minimum additional water is required for SUZ outdoor unit. If there is enough water amount inside water pipe, radiator, or underfloor heating, no buffer tank is required.



New 2 zone kit

- You can select from 3 types of pump operations, 1. Fixed speed mode, 2. Fixed pressure mode, 3. Energy saving mode, depending on your preference.
- All-in-one kit: Key functional components are incorporated in 2 zone kit.
- Easy installation: G1 screw type flexi-piping to avoid brazing.
- Compact size: Just to fit on the top of cylinder unit, also wall mountable.

High Performance

Improved Efficiency

With additional thermistor (THW5A), η_{wh} [%] rating is improved by more than 40% compared to previous C generation 200L models allowing 170L and 200L to achieve A+, the highest possible domestic hot water efficiency rank.

Excellent DHW efficiency



	170L (L)	200L (L)	300L (XL)
	η_{wh} [%]	η_{wh} [%]	η_{wh} [%]
C Generation	-	96 ~ 104	-
D Generation	136 ~ 148	138 ~ 159	118 ~ 128
DHW Rank	A+	A+	A/A+

Thermistor Position of Cylinder

The thermistor position is now selectable allowing the unit to accommodate for different water demands in order to maximise the efficiency of the unit for any size of household or application.

Using two thermistors equipped with all sizes of tanks, you can now select the DHW recharge amount from two options (Standard/Large). It helps accommodate for different water demands in order to maximise the efficiency of the unit for any size of household or application. This mode can be selected from main remote controller.

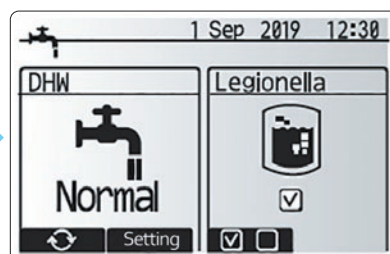
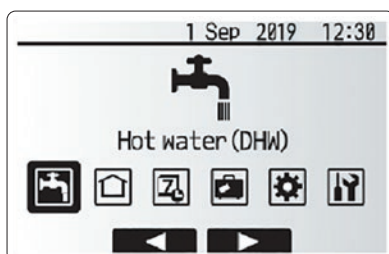

DHW recharge (Standard / Large)

Thermistors

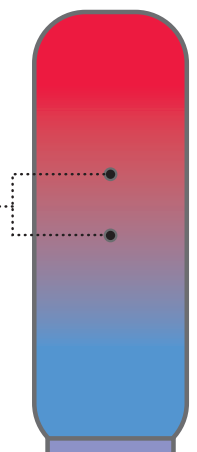

Unique Technology of ecodan

Auto Adaptation Improvement

Mitsubishi Electric's Auto Adaptation function automatically tracks changes in the actual room temperature and outdoor temperature and adjusts the flow temperatures accordingly.

Aiming to realise further comfort and energy savings, Mitsubishi Electric has already introduced a revolutionary new controller. Auto Adaptation function measures the room temperature and outdoor temperature, and then calculates the required heating capacity for the room. Simply stated, the flow temperature is automatically controlled according to the required heating capacity, while optimal room temperature is maintained at all times, ensuring the appropriate heating capacity and preventing energy from being wasted. Furthermore, by estimating future changes in room temperature, the system works to prevent unnecessary increases and decreases in the flow temperature. Accordingly, Auto Adaptation maximises both comfort and energy savings without the need for complicated settings. For Mitsubishi Electric ecodan, by introducing improved control logic, we achieved faster heating and more energy saving.

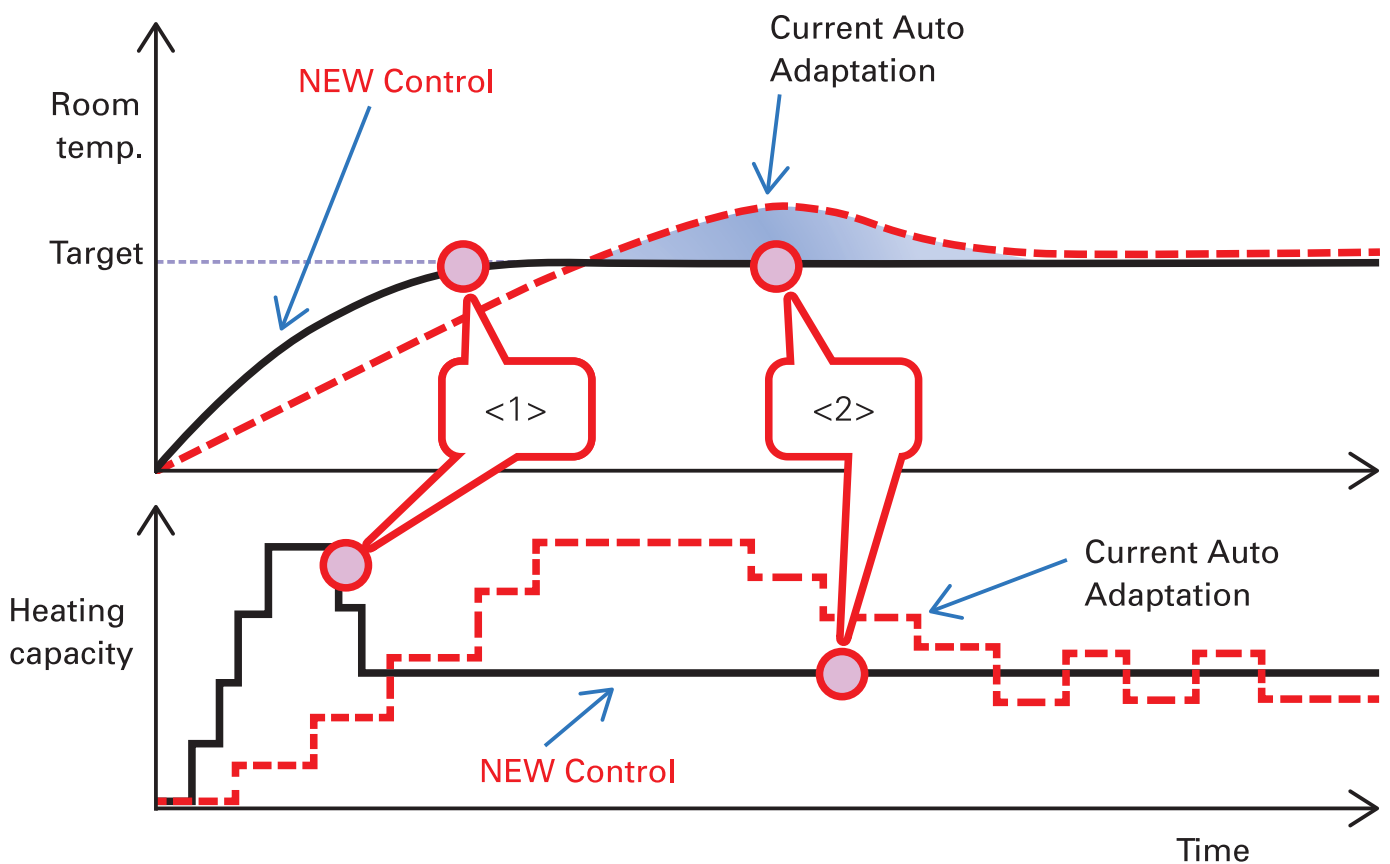

- <1> Fast heating with improved accuracy in learning building heat load
- <2> Energy saving by avoiding over heating and capacity fluctuation with better control response, i.e. control interval and resolution

Unique Technology of ecodan

2 Zone Control (for heating/cooling)

Improved Simultaneous Control of Two Different Zones

Using ecodan, it is possible to control two different flow temperatures, thereby managing two different heating load requirements. The system can adjust and maintain two flow temperatures when different temperatures are required for different rooms; for example, controlling a flow temperature of 40°C for the bedroom radiators and another flow temperature of 30°C for the living room floor heating. Moreover, mixing valve control is advanced for improving zone 2 comfort by using heat storage in buffer tank. Also, new controller monitors the temperature inside buffer tank and prioritizes using the heat inside the tank to avoid frequent on/off operation when using 2 zone control.

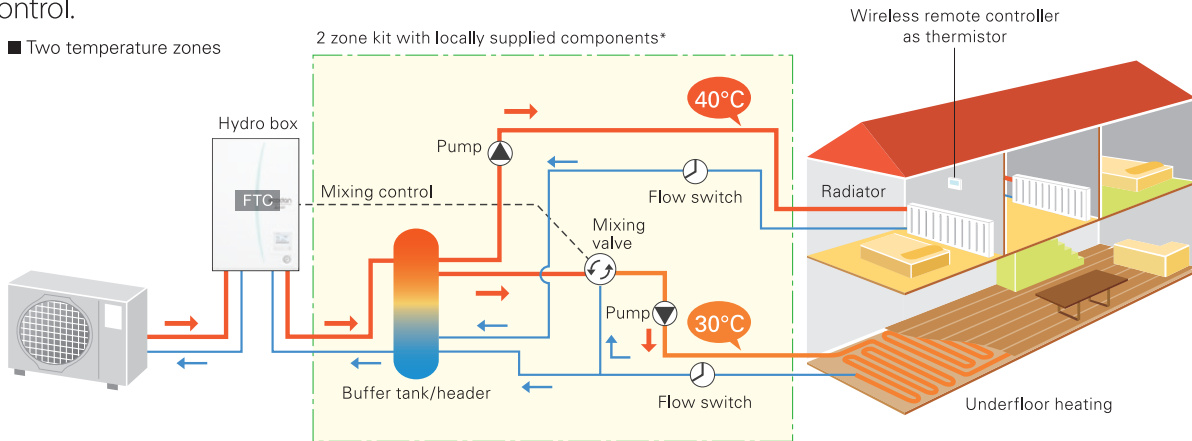

*Items such as a mixing tank, mixing valve flow switch and pumps are not included and need to be purchased locally.

Improved Smart Grid Ready

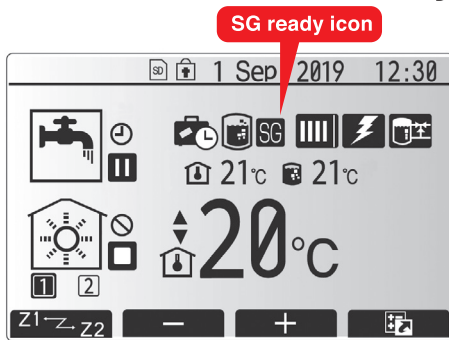

Pattern	Operation	R/C indication
1	Normal operation	—
2	Switch OFF command	SG
3	Switch ON recommendation	
4	Switch ON command (while PV is generating)	

SG ready icon on main remote controller indicates that SG ready is active and its setting can be easily operated with main remote controller. Improved SG ready function enables you to choose the target temperature in unit of 1°C. Also, when PV manager is interlocked with ecodan and ecodan receives its signal, heat is stored as much as possible while heat pump and/or electric heater running. Heat storage in large buffer tank will be made available for zone2 as well when peak cut signal is on. As long as a mixing valve keeps its control, zone2 flow temperature is maintained.

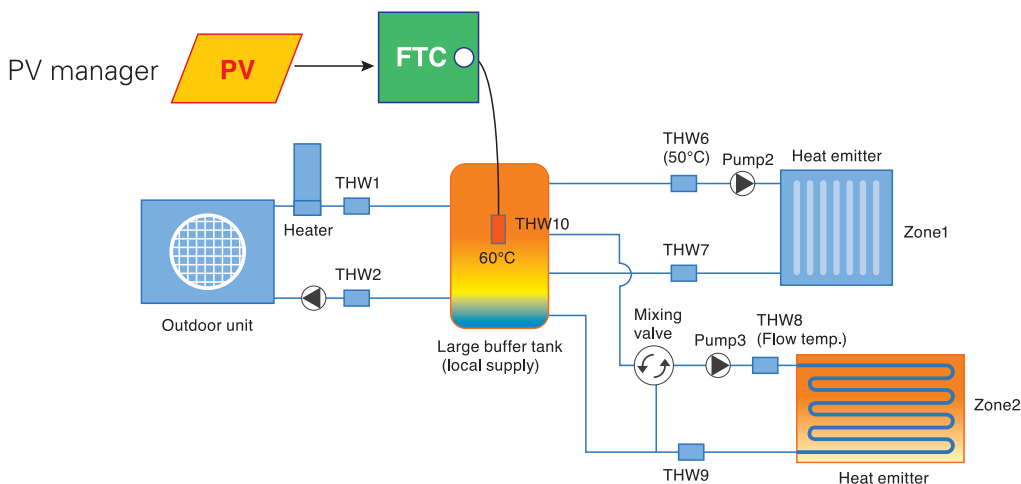

New R32 Eco Inverter

Energy efficient and environmentally friendly heating.

New Look and Expanded Line-up



SUZ-SWM40/60/80VA

- New black grill and sticker
- New line-up added (60 and 80)

	New	New
40	60	80
●	●	●

High Performance

A+++ / A++ energy class in space heating & combination heater. Part Load efficiency SCOP up to 4.62 at low temperature.

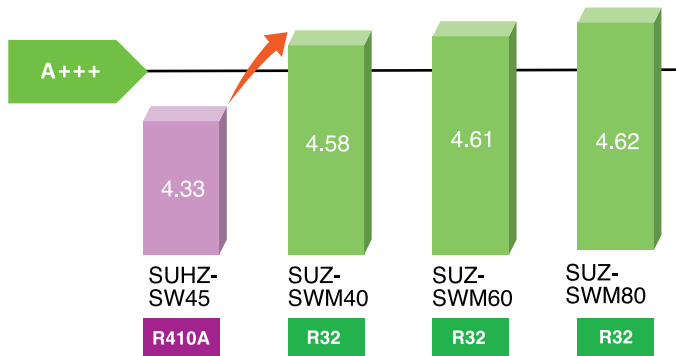

Low Noise

Compared with conventional outdoor unit, New R32 eco inverter achieved lower noise level, assuring the flexibility of installation in dense residential areas.

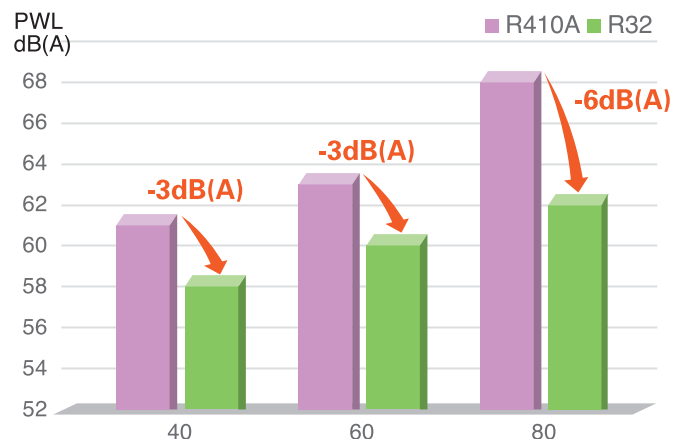

*Compared SUZ-SWM40/60/80VA with SUHZ-SW45VA/PUHZ-SW50VKA/PUHZ-SW75VHA

60°C Flow Temperature

Along with its increased lower operating range the New R32 range is capable of delivering a higher flow rate of 60°C, 5°C higher than the conventional model.

Guaranteed Operating Range Expansion

Guaranteed heating operating range is extended to -20°C.

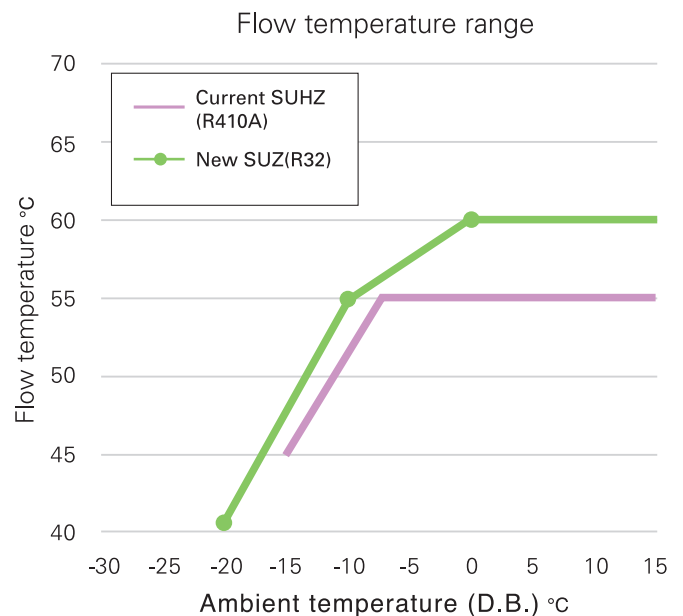
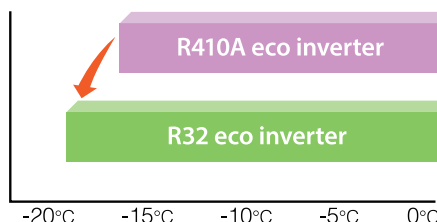

Outdoor unit

R32

Model name				SUZ-SWM40VA	SUZ-SWM60VA	SUZ-SWM80VA
Dimensions		HxWxD	mm	880x840x330	880x840x330	880x840x330
Weight			kg	54	54	54
power supply (V / Phase / Hz)				230/1-ph/50	230/1-ph/50	230/1-ph/50
Heating	A7W35	Nominal	kW	4.0	6.0	7.5
		COP		5.20	4.86	4.70
	A2W35	Nominal	kW	4.0	5.0	6.5
		COP		3.90	3.33	3.40
	A-7W35	Nominal	kW	5.0	6.0	6.8
		COP	kW	3.13	2.98	2.80
Average climate water outlet 35°C		Class*		A+++	A+++	A+++
		ηS		180	181	182
		SCOP		4.58	4.61	4.62
Average climate water outlet 55°C		Class*		A++	A++	A++
		ηS		129	130	131
		SCOP		3.29	3.33	3.35
DHW 200L Load Profile		Class		A+	A+	A+
		ηWH		159	148	148
		MFT(°C)		60	60	60
Cooling	A35W7	Nominal	kW	4.5	5.0	5.4
		EER		3.29	3.03	3.00
	A35W18	Nominal	kW	5.6	6.0	6.3
		EER		4.97	4.88	4.80
PWL (Heating)			dB(A)	58	60	62
Max operating current			A	13.9	13.9	13.9
Breaker size			A	16	16	16
Piping	Diameter	Liquid/Gas	mm	6.35/12.7	6.35/12.7	6.35/12.7
	Length	Out-In	m	5-30	5-30	5-30
	Height	Out-In	m	Max 30	Max 30	Max 30
Guaranteed Operating range	Heating		°C	-20°C~24°C	-20°C~24°C	-20°C~24°C
	DHW		°C	-20°C~35°C	-20°C~35°C	-20°C~35°C
	Cooling		°C	10°C~46°C	10°C~46°C	10°C~46°C

*Energy efficiency class according to EU No.813/2013 regarding heating under average climate conditions for low/medium temperature conditions

Optional parts <Outdoor unit>

Part name	Model name	R32			R410A (Power Inverter)					R410A (Zubadan)			
		SUZ-SWM40VA	SUZ-SWM60VA	SUZ-SWM80VA	PUHZ-SW75V/YAA	PUHZ-SW100V/YAA	PUHZ-SW120V/YHA	PUHZ-SW160YKA	PUHZ-SW200YKA	PUHZ-SHW80V/YAA	PUHZ-SHW112V/YAA	PUHZ-SHW140YHA	PUHZ-SHW230YKA2
Connector for drain hose heater signal output	PAC-SE60RA-E	-	-	-	✓	✓	✓	✓	✓	✓	✓	✓	✓
Air discharge guide	MAC-886SG-E	✓	✓	✓	-	-	-	-	-	-	-	-	-
	PAC-SG59SG-E	-	-	-	-	-	✓	-	-	-	-	✓	-
	PAC-SH96SG-E	-	-	-	✓	✓	✓	✓	✓	✓	✓	-	✓
Air protection guide	PAC-SH63AG-E	-	-	-	-	-	✓	-	-	-	-	✓	-
	PAC-SH95AG-E	-	-	-	✓	✓	-	✓	✓	✓	✓	-	✓
Attachement	PAC-SH82AT-E	-	-	-	✓	✓	-	-	✓	✓	✓	-	✓
Drain socket	PAC-SG61DS-E	-	-	-	✓	✓	✓	✓	✓	✓	✓	-	-
Centralized drain pan	PAC-SG64DP-E	-	-	-	-	-	✓	-	-	-	-	-	-
	PAC-SH97DP-E	-	-	-	-	-	-	✓	✓	-	-	-	-
	PAC-SJ83DP-E	-	-	-	-	✓	-	-	-	✓	✓	-	-
Defrost heater	MAC-642BH-U1	✓	✓	✓	-	-	-	-	-	-	-	-	-
Control/Service tool	PAC-SK52ST	-	-	-	✓	✓	✓	✓	✓	✓	✓	✓	✓

Optional parts <Interface/Flow temperature control>

Part name	Model name	R32			R410A (Power Inverter)					R410A (Zubadan)				Remarks
		SUZ-SWM40VA	SUZ-SWM60VA	SUZ-SWM80VA	PUHZ-SW75V/YAA	PUHZ-SW100V/YAA	PUHZ-SW120V/YHA	PUHZ-SW160YKA	PUHZ-SW200YKA	PUHZ-SHW80V/YAA	PUHZ-SHW112V/YAA	PUHZ-SHW140YHA	PUHZ-SHW230YKA2	
Capacity step control interface Flow temperature controller	PAC-IF011B-E	-	-	-	✓	✓	✓	✓	✓	✓	✓	✓	✓	1 PC board w/ Case
	PAC-IF032B-E	-	-	-	✓	✓	✓	✓	✓	✓	✓	✓	✓	1 PC board w/ Case
System Controllers	PAC-IF071B-E	✓*	✓*	✓*	✓	✓	✓	✓	✓	✓	✓	✓	✓	1 PC board w/ Case
	PAC-IF072B-E	✓*	✓*	✓*	✓	✓	✓	✓	✓	✓	✓	✓	✓	1 PC board w/ Case
	PAC-IF073B-E	✓*	✓*	✓*	✓	✓	✓	✓	✓	✓	✓	✓	✓	1 PC board w/ Case
Thermistor	PAC-TH011-E	✓*	✓*	✓*	✓	✓	✓	✓	✓	✓	✓	✓	✓	

* Pressure sensor (PAC-PS01-E) is required.

R410A

Model name				Power Inverter							
				PUHZ-SW75VAA	PUHZ-SW75YAA	PUHZ-SW100VAA	PUHZ-SW100YAA	PUHZ-SW120VHA	PUHZ-SW120YHA	PUHZ-SW160YKA	PUHZ-SW200YKA
Dimensions	HxWxD	mm		1020x1050x480	1020x1050x480	1020x1050x480	1020x1050x480	1350x950x330	1350x950x330	1338x1050x330	1338x1050x330
Weight		kg		92	104	114	126	118	130	136	136
power supply (V / Phase / Hz)				230/1-ph/50	400/3-ph/50	230/1-ph/50	400/3-ph/50	230/1-ph/50	400/3-ph/50	400/3-ph/50	400/3-ph/50
Heating	A7W35	Nominal	kW	8.0	8.0	11.2	11.2	16.0	16.0	22.0	25.0
		COP		4.40	4.40	4.46	4.46	4.10	4.10	4.20	4.00
	A2W35	Nominal	kW	7.5	7.5	10.0	10.0	12.0	12.0	16.0	20.0
		COP		3.40	3.40	3.32	3.32	3.24	3.24	3.11	2.80
	A-7W35	Nominal	kW	6.3	6.3	10.0	10.0	11.2	11.2	13.4	15.3
		COP	kW	3.16	3.16	2.85	2.85	2.85	2.85	2.80	2.67
Average climate water outlet 35°C	Class*			A++	A++	A++	A++	A++	A++	A++	A++
	ηS			162	160	167	165	162	162	161	163
	SCOP			4.12	4.07	4.25	4.21	4.13	4.13	4.10	4.14
Average climate water outlet 55°C	Class*			A++	A++	A++	A++	A++	A++	A++	A++
	ηS			129	128	130	129	125	125	125	127
	SCOP			3.31	3.28	3.33	3.30	3.21	3.21	3.20	3.26
DHW 200L/300L Load Profile	Class			A+/A	A+/A	A+/A	A+/A	A+/A	A+/A	-	-
	ηWH			145/120	145/120	145/120	145/120	138/118	138/118	-	-
	MFT(°C)			60	60	60	60	60	60	-	-
Cooling	A35W7	Nominal	kW	7.1	7.1	10.0	10.0	12.5	12.5	16.0	20.0
		EER		2.70	2.70	2.83	2.83	2.32	2.32	2.76	2.25
	A35W18	Nominal	kW	7.1	7.1	10.0	10.0	14.0	14.0	18.0	22.0
		EER		4.43	4.43	4.47	4.47	4.08	4.08	4.56	4.10
PWL (Heating)		dB(A)		58	58	60	60	72	72	78	78
Max operating current		A		22.0	11.5	28.0	12.0	29.5	13.0	19.0	21.0
Breaker size		A		25	16	32	16	32	16	25	32
Piping	Diameter	Liquid/Gas	mm	9.52/15.88	9.52/15.88	9.52/15.88	9.52/15.88	9.52/15.88	9.52/15.88	9.52/25.4	12.7/25.4
	Length	Out-In	m	2-40	2-40	2-75	2-75	2-75	2-75	2-80	2-80
	Height	Out-In	m	Max 10	Max 10	Max 10	Max 10	Max 30	Max 30	Max 30	Max 30
Guaranteed Operating range	Heating		°C	-20°C~21°C	-20°C~21°C	-20°C~21°C	-20°C~21°C	-20°C~21°C	-20°C~21°C	-20°C~21°C	-20°C~21°C
	DHW		°C	-20°C~35°C	-20°C~35°C	-20°C~35°C	-20°C~35°C	-20°C~35°C	-20°C~35°C	-20°C~35°C	-20°C~35°C
	Cooling		°C	-15°C~46°C	-15°C~46°C	-15°C~46°C	-15°C~46°C	-15°C~46°C	-15°C~46°C	-15°C~46°C	-15°C~46°C

*Energy efficiency class according to EU No.813/2013 regarding heating under average climate conditions for low/medium temperature conditions

Model name				Zubadan					
				PUHZ-SHW80VAA	PUHZ-SHW80YAA	PUHZ-SHW112VAA	PUHZ-SHW112YAA	PUHZ-SHW140YHA	PUHZ-SHW230YKA2
Dimensions	HxWxD	mm		1020x1050x480	1020x1050x480	1020x1050x480	1020x1050x480	1350x950x330	1338x1050x330
Weight		kg		116	128	116	128	134	143
power supply (V / Phase / Hz)				230/1-ph/50	400/3-ph/50	230/1-ph/50	400/3-ph/50	400/3-ph/50	400/3-ph/50
Heating	A7W35	Nominal	kW	8.0	8.0	11.2	11.2	14.0	23.0
		COP		4.65	4.65	4.46	4.46	4.22	3.65
	A2W35	Nominal	kW	8.0	8.0	11.2	11.2	14.0	23.0
		COP		3.55	3.55	3.22	3.22	2.96	2.37
	A-7W35	Nominal	kW	8.0	8.0	11.2	11.2	14.0	23.0
		COP	kW	3.48	3.48	3.34	3.34	2.58	2.85
Average climate water outlet 35°C	Class*			A++	A++	A++	A++	A++	A++
	ηS			169	167	171	169	163	164
	SCOP			4.31	4.26	4.34	4.31	4.16	4.18
Average climate water outlet 55°C	Class*			A++	A++	A++	A++	A++	A++
	ηS			133	132	135	135	127	127
	SCOP			3.40	3.36	3.46	3.44	3.25	3.25
DHW 200L/300L Load Profile	Class			A+/A	A+/A	A+/A	A+/A	A+/A	-
	ηWH			145/120	145/120	145/120	145/120	138/118	-
	MFT(°C)			60	60	60	60	60	-
Cooling	A35W7	Nominal	kW	7.1	7.1	10.0	10.0	12.5	20.0
		EER		3.31	3.31	2.83	2.83	2.17	2.22
	A35W18	Nominal	kW	7.1	7.1	10.0	10.0	12.5	20.0
		EER		4.52	4.52	4.74	4.74	4.26	3.55
PWL (Heating)		dB(A)		59	59	60	60	70	75
Max operating current		A		22.0	13.0	28.0	13.0	13.0	20.0
Breaker size		A		25	16	32	16	16	25
Piping	Diameter	Liquid/Gas	mm	9.52/15.88	9.52/15.88	9.52/15.88	9.52/15.88	9.52/15.88	12.7/25.4
	Length	Out-In	m	2-75	2-75	2-75	2-75	2-75	2-80
	Height	Out-In	m	Max 30	Max 30	Max 30	Max 30	Max 30	Max 30
Guaranteed Operating range	Heating		°C	-28°C~21°C	-28°C~21°C	-28°C~21°C	-28°C~21°C	-28°C~21°C	-25°C~21°C
	DHW		°C	-28°C~35°C	-28°C~35°C	-28°C~35°C	-28°C~35°C	-28°C~35°C	-25°C~35°C
	Cooling		°C	-15°C~46°C	-15°C~46°C	-15°C~46°C	-15°C~46°C	-15°C~46°C	-15°C~46°C

*Energy efficiency class according to EU No.813/2013 regarding heating under average climate conditions for low/medium temperature conditions

Indoor unit

<Cylinder unit (Heating only)>

			Small capacity											
Model name			EHST17D-VM2D	EHST20D-MED	EHST20D-VM2D	EHST20D-VM6D	EHST20D-VM9D	EHST20D-VM9ED	EHST20D-TM9D	EHST30D-MED	EHST30D-VM6ED	EHST30D-VM9ED	EHST30D-TM9ED	
Type			Heating only											
Expansion vessel			✓		✓	✓	✓	✓	✓					
Booster heater (2/6/9)			✓		✓	✓	✓	✓	✓			✓	✓	
Dimensions			HxWxD	mm	1600x595x680						2050x595x680			
Weight (empty)			kg	93	98	104	105	106	101	106	113	115	116	
Control Board Power supply (Phase / V / Hz)				~ /N, 230V, 50Hz	~ /N, 230V, 50Hz	~ /N, 230V, 50Hz	~ /N, 230V, 50Hz	~ /N, 230V, 50Hz	~ /N, 230V, 50Hz	~ /N, 230V, 50Hz	~ /N, 230V, 50Hz	~ /N, 230V, 50Hz	~ /N, 230V, 50Hz	
Heater	Booster heater	Power supply (Phase / V / Hz)	~ /N, 230V, 50Hz	—	~ /N, 230V, 50Hz	~ /N, 230V, 50Hz	3 ~, 400V, 50Hz	3 ~, 400V, 50Hz	3 ~, 400V, 50Hz	3 ~, 230V, 50Hz	—	~ /N, 230V, 50Hz	3 ~, 400V, 50Hz	
		Capacity	kW	2	—	2	2+4	3+6	3+6	3+6	—	2+4	3+6	
		Current	A	9	—	9	26	13	13	23	—	26	13	
		Breaker size	A	16	—	16	32	16	16	32	—	32	16	
Domestic hot water tank	Volume / Material	L / -	170 / Stainless steel	200 / Stainless steel						300 / Stainless steel				
Guaranteed operating range *1	Ambient	°C	0 - 35 (≤80%RH)											
	Outdoor	Heating	°C	See outdoor unit spec table										
		Cooling	°C	—										
Target temperature range	Heating	Room temperature	°C	10 - 30										
		Flow temperature	°C	20 - 60										
	Cooling	Room temperature	°C	—										
		Flow temperature	°C	—										
DHW tank performance	Max. hot water temperature	°C	70	*2	70						*2	70		
	Water heater energy efficiency class		A+						A - A+					
Sound pressure level (PWL)			dB (A)	41										

*1 The indoor environment must be frost-free

*2 For the model without booster heater and immersion heater, the maximum allowable hot water temperature is 3°C lower than maximum outlet water of outdoor unit. For the maximum outlet water of outdoor unit, refer to outdoor unit data book.

<Cylinder unit (Heating only)>

			Medium capacity											
Model name			EHST20C-MED	EHST20C-VM2D	EHST20C-VM6D	EHST20C-VM9D	EHST20C-VM9ED	EHST20C-TM9D	EHST30C-MED	EHST30C-VM6ED	EHST30C-VM9ED	EHST30C-TM9ED		
Type			Heating only											
Expansion vessel				✓	✓	✓		✓						
Booster heater (2/6/9)				✓	✓	✓	✓	✓		✓	✓	✓		
Dimensions			HxWxD	mm	1600x595x680						2050x595x680			
Weight (empty)			kg	106	113	114	115	109	115	118	120	121		
Control Board Power supply (Phase / V / Hz)				~ /N, 230V, 50Hz	~ /N, 230V, 50Hz	~ /N, 230V, 50Hz	~ /N, 230V, 50Hz	~ /N, 230V, 50Hz	~ /N, 230V, 50Hz	~ /N, 230V, 50Hz	~ /N, 230V, 50Hz	~ /N, 230V, 50Hz		
Heater	Booster heater	Power supply (Phase / V / Hz)	—	~ /N, 230V, 50Hz	~ /N, 230V, 50Hz	3 ~, 400V, 50Hz	3 ~, 400V, 50Hz	3 ~, 400V, 50Hz	3 ~, 400V, 50Hz	—	~ /N, 230V, 50Hz	3 ~, 400V, 50Hz		
		Capacity	kW	—	2	2+4	3+6	3+6	3+6	—	2+4	3+6		
		Current	A	—	9	26	13	13	23	—	26	13		
		Breaker size	A	—	16	32	16	16	32	—	32	16		
Domestic hot water tank	Volume / Material	L / -	200 / Stainless steel						300 / Stainless steel					
Guaranteed operating range *1	Ambient	°C	0 - 35 (≤80%RH)											
	Outdoor	Heating	°C	See outdoor unit spec table										
		Cooling	°C	—										
Target temperature range	Heating	Room temperature	°C	10 - 30										
		Flow temperature	°C	20 - 60										
	Cooling	Room temperature	°C	—										
		Flow temperature	°C	—										
DHW tank performance	Max. hot water temperature	°C	*2	70						*2	70			
	Water heater energy efficiency class		A+						A					
Sound pressure level (PWL)			dB (A)	40										

*1 The indoor environment must be frost-free

*2 For the model without booster heater and immersion heater, the maximum allowable hot water temperature is 3°C lower than maximum outlet water of outdoor unit. For the maximum outlet water of outdoor unit, refer to outdoor unit data book.

<Hydro box (Heating only)>

			Small capacity						Medium capacity						Large capacity		
Model name			EHSD-MED	EHSD-VM2D	EHSD-VM6D	EHSD-VM9D	EHSD-VM9ED	EHSD-TM9D	EHSC-MED	EHSC-VM2D	EHSC-VM6D	EHSC-VM9D	EHSC-VM9ED	EHSC-TM9D	EHSE-VM9ED	EHSE-MED	
Type			Heating only														
Expansion vessel				✓	✓	✓		✓		✓	✓	✓	✓	✓			
Booster heater (2/6/9)				✓	✓	✓	✓	✓		✓	✓	✓	✓	✓	✓		
Dimensions			HxWxD	mm	800x530x360										950x600x360		
Weight (empty)			kg	36	43	44	105	106	101	40	47	48	48	43	48		
Control Board Power supply (Phase / V / Hz)				~ /N, 230V, 50Hz	~ /N, 230V, 50Hz	~ /N, 230V, 50Hz	~ /N, 230V, 50Hz	~ /N, 230V, 50Hz	~ /N, 230V, 50Hz	~ /N, 230V, 50Hz	~ /N, 230V, 50Hz	~ /N, 230V, 50Hz	~ /N, 230V, 50Hz	~ /N, 230V, 50Hz	~ /N, 230V, 50Hz		
Heater	Booster heater	Power supply (V / Phase / Hz)	—	~ /N, 230V, 50Hz	~ /N, 230V, 50Hz	3 ~, 400V, 50Hz	3 ~, 400V, 50Hz	3 ~, 230V, 50Hz	—	~ /N, 230V, 50Hz	~ /N, 230V, 50Hz	3 ~, 400V, 50Hz	3 ~, 400V, 50Hz	3 ~, 230V, 50Hz	3 ~, 400V, 50Hz		
		Capacity	kW	—	2	2+4	3+6	3+6	3+6	—	2	2+4	3+6	3+6	3+6		
		Current	A	—	9	26	13	13	23	—	9	26	13	13	23		
		Breaker size	A	—	16	32	16	16	32	—	16	32	16	16	32		
Guaranteed operating range *1	Ambient	L / -	0 - 35 (≤80%RH)														
	Outdoor	Heating	°C	See outdoor unit spec table													
		Cooling	°C	—													
Target temperature range	Heating	Room temperature	°C	10 - 30													
		Flow temperature	°C	20 - 60													
	Cooling	Room temperature	°C	—													
		Flow temperature	°C	—													
Sound pressure level (PWL)			dB (A)	41						40						45	

*1 The indoor environment must be frost-free.

<Cylinder unit (Reversible)>

			Small capacity			Medium capacity		
Model name			ERST17D-VM2D	ERST20D-VM2D	ERST30D-VM2ED	ERST20C-VM2D	ERST30C-VM2ED	
Type			Heating and Cooling					
Expansion vessel			✓	✓		✓		
Booster heater (2/6/9)			✓	✓	✓	✓	✓	
Dimensions	HxWxD	mm	1400x595x680	1600x595x680	2050x595x680	1600x595x680		2050x595x680
Weight (empty)		kg	93	104	114	113		120
Control Board Power supply (Phase / V / Hz)			~ /N, 230V, 50Hz	~ /N, 230V, 50Hz	~ /N, 230V, 50Hz	~ /N, 230V, 50Hz		~ /N, 230V, 50Hz
Heater	Booster heater	Power supply (V / Phase / Hz)	~ /N, 230V, 50Hz	~ /N, 230V, 50Hz	~ /N, 230V, 50Hz	~ /N, 230V, 50Hz		~ /N, 230V, 50Hz
		Capacity	kW	2	2	2		2
		Current	A	9	9	9		9
		Breaker size	A	16	16	16		16
Domestic hot water tank	Volume / Material	L / -	170 / Stainless steel	200 / Stainless steel	300 / Stainless steel		200 / Stainless steel	300 / Stainless steel
Guranteed operating range *1	Ambient	°C	0 - 35 (≤80%RH)					
	Outdoor	Heating	See outdoor unit spec table					
		Cooling	See outdoor unit spec table *2					
Target temperature range	Heating	Room temperature	10 - 30					
		Flow temperature	20 - 60					
	Cooling	Room temperature	-					
		Flow temperature	5 - 25					
DHW tank performance		Flow temperature	70					
		Max. hot water temperature	A+	A+	A - A+		A+	A
Sound pressure level (PWL)	Water heater energy efficiency class	dB (A)	41			40		

*1 The indoor environment must be frost-free.

*2 During cooling operation at low outdoor temperature (10°C or lower), frozen water may cause damage on plate heat exchanger.

<Hydro box (Reversible)>

			Small capacity		Medium capacity		Large capacity		
Model name			ERSD-MED	ERSD-VM2D	ERSC-MED	ERSC-VM2D	ERSE-YM9ED	ERSE-MED	
Type			Heating only						
Expansion vessel				✓		✓			
Booster heater (2/6/9)				✓		✓	✓		
Dimensions	HxWxD	mm	800x530x360				950x600x360		
Weight (empty)		kg	38	44	40	47	64	62	
Control Board Power supply (Phase / V / Hz)			~ /N, 230V, 50Hz	~ /N, 230V, 50Hz	~ /N, 230V, 50Hz	~ /N, 230V, 50Hz	~ /N, 230V, 50Hz	~ /N, 230V, 50Hz	
Heater	Booster heater	Power supply (V / Phase / Hz)	-	~ /N, 230V, 50Hz	-	~ /N, 230V, 50Hz	3 ~, 400V, 50Hz		
		Capacity	kW	-	2	-	2	3+6	
		Current	A	-	9	-	9	13	-
		Breaker size	A	-	16	-	16	16	-
Guranteed operating range *1	Ambient	°C	0 - 35 (≤80%RH)						
	Outdoor	Heating	See outdoor unit spec table						
		Cooling	See outdoor unit spec table						
Target temperature range	Heating	Room temperature	10 - 30						
		Flow temperature	20 - 60						
	Cooling	Room temperature	-						
		Flow temperature	5-25						
Sound pressure level (PWL)		dB (A)	41			40		45	

*1 The indoor environment must be frost-free

*2 If you use our system n cooling mode at the low ambient temperature (10°C or below), there are some risks of plate heat exchanger breaking by frozen water.

Optional parts <Indoor unit>

Part name	Model name	Cylinder	Hydrobox	Specification
Wireless remote controller	PAR-WT50R-E	✓	✓	
Wireless receiver	PAR-WR51R-E	✓	✓	
Thermistors	PAC-SE41TS-E	✓	✓	For room temp.
	PAC-TH011-E	✓	✓	For zone (flow and return temp.)
	PAC-TH011TK2-E	-	✓	For tank temp. (5m)
	PAC-TH011TKL2-E	-	✓	For tank temp. (30m)
	PAC-TH012HT-E	✓	✓	For boiler and buffer (5m)
	PAC-TH012HTL-E	✓	✓	For boiler and buffer (30m)
Immersion heater	PAC-IH01V2-E	✓	-	1Ph 1kW
	PAC-IH03V2-E	✓	-	1Ph 3kW
Joint pipe	PAC-SG72RJ-E	✓	✓	For PUAH-SW75 φ6.35→φ9.52
	PAC-SG74RJ-E	✓	✓	For PUAH-SW75 φ12.7→φ15.88
Wi-Fi interface	MAC-567IF-E	✓	✓	
2 Zone kit	PAC-TZ02-E	✓	✓	
Expansion vessel	PAC-EVP12-E	✓	-	12L

Combination Table

Split indoor/outdoor unit combination		R32			R410A													
		SUZ-SWM40VA	SUZ-SWM60VA	SUZ-SWM80VA	PUHZ-SW75VAA	PUHZ-SW75YAA	PUHZ-SW100VAA	PUHZ-SW100YAA	PUHZ-SW120VHA	PUHZ-SW120YHA	PUHZ-SW160YKA	PUHZ-SW200YKA	PUHZ-SHW80VAA	PUHZ-SHW80YAA	PUHZ-SHW112VAA	PUHZ-SHW112YAA	PUHZ-SHW140YHA	PUHZ-SHW230YKA2
Heating only Cylinder	EHST17D-VM2D	●	●	●	●	●												
	EHST20D-MED	●	●	●	●	●												
	EHST20D-VM2D	●	●	●	●	●												
	EHST20D-VM6D	●	●	●	●	●												
	EHST20D-YM9D	●	●	●	●	●												
	EHST20D-YM9ED	●	●	●	●	●												
	EHST20D-TM9D	●	●	●	●	●												
	EHST30D-MED			●	●	●												
	EHST30D-VM6ED			●	●	●												
	EHST30D-YM9ED			●	●	●												
	EHST30D-TM9ED			●	●	●												
	EHST20C-MED							●	●	●	●			●	●	●	●	●
	EHST20C-VM2D							●	●	●	●			●	●	●	●	●
	EHST20C-VM6D							●	●	●	●			●	●	●	●	●
	EHST20C-YM9D							●	●	●	●			●	●	●	●	●
	EHST20C-YM9ED							●	●	●	●			●	●	●	●	●
	EHST20C-TM9D							●	●	●	●			●	●	●	●	●
	EHST30C-MED							●	●	●	●			●	●	●	●	●
	EHST30C-VM6ED							●	●	●	●			●	●	●	●	●
EHST30C-YM9ED							●	●	●	●			●	●	●	●	●	
EHST30C-TM9ED							●	●	●	●			●	●	●	●	●	
Reversible Cylinder	ERST17D-VM2D	●	●	●	●	●												
	ERST20D-VM2D	●	●	●	●	●												
	ERST30D-VM2ED			●	●	●												
	ERST20C-VM2D							●	●	●	●			●	●	●	●	●
	ERST30C-VM2ED							●	●	●	●			●	●	●	●	●
Heating only Hydro box	EHSD-MED	●	●	●	●	●												
	EHSD-VM2D	●	●	●	●	●												
	EHSD-VM6D	●	●	●	●	●												
	EHSD-YM9D	●	●	●	●	●												
	EHSD-YM9ED	●	●	●	●	●												
	EHSD-TM9D	●	●	●	●	●												
	EHSC-MED							●	●	●	●			●	●	●	●	●
	EHSC-VM2D							●	●	●	●			●	●	●	●	●
	EHSC-VM6D							●	●	●	●			●	●	●	●	●
	EHSC-YM9D							●	●	●	●			●	●	●	●	●
	EHSC-YM9ED							●	●	●	●			●	●	●	●	●
	EHSC-TM9D							●	●	●	●			●	●	●	●	●
	EHSE-YM9ED											●	●					●
	EHSE-MED											●	●					●
Reversible Hydro box	ERSD-MED	●	●	●	●	●												
	ERSD-VM2D	●	●	●	●	●												
	ERSC-MED							●	●	●	●			●	●	●	●	●
	ERSC-VM2D							●	●	●	●			●	●	●	●	●
	ERSE-YM9ED											●	●					●
	ERSE-MED											●	●					●

MITSUBISHI ELECTRIC CORPORATION

HEAD OFFICE: TOKYO BLDG., 2-7-3, MARUNOUCHI, CHIYODA-KU, TOKYO 100-8310, JAPAN

<http://Global.MitsubishiElectric.com>

